

# SC Protector

## Self Control Protector

### Innovative way of safety control for Li-ion rechargeable battery

At any moment, SC Protector system monitors the voltage of Li-ion rechargeable battery and its heater fuses the fuse at the same instant when the system detects the overcharge. Usual protection element takes long time to work because it works due to temperature rise of battery cells.

The difference of SC Protector provides you high degree of freedom in the design of protection circuit.

#### 1. Application

Typical application of protection for a Lithium ion rechargeable battery from overcharging is shown in the figure below.

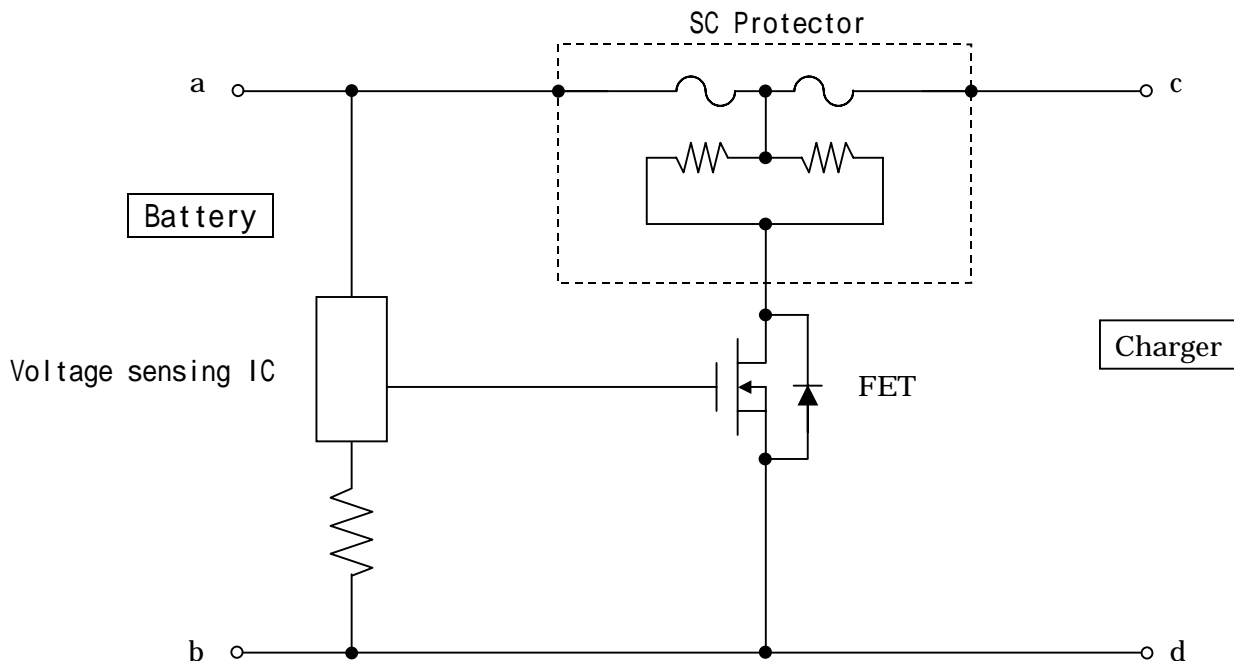

When the voltage between a and b exceeds the pre-set limit value, the output of the voltage detector IC becomes high and the FET is switched on. As a result, current flow through the heater of the protector, the fuses melt, and the battery stops to be charged any longer.

Since the two fuses cut-off the voltage supplies from the charger and the battery, the SC Protector stops to be heated immediately and thus, the safety control protection is provided against both excess voltage and excessive heating.

**Sony Chemicals Corporation**  
**SIP Division**  
1-11-2, Osaki, Shinagawa-ku, Tokyo, 141-0032 Japan  
TEL+81-3-5435-3943 FAX+81-3-5435-3072

## 2. Characteristics of SC Protector

### 2.1. Necessity

#### 2.1.1. Reliability of the protection circuit

All Li-ion rechargeable battery packs are equipped with at least one protection circuit (ex.IC+FET).

In this case, when an IC or FET breaks, overcharge can't be controlled any more, and the temperature rise of the battery cell can invite very dangerous thermo-runaway leading to smoking or firing.

The trouble of the IC and FET actually occurs.

Therefore, double protection is needed to ensure the safety of Li-ion battery packs.

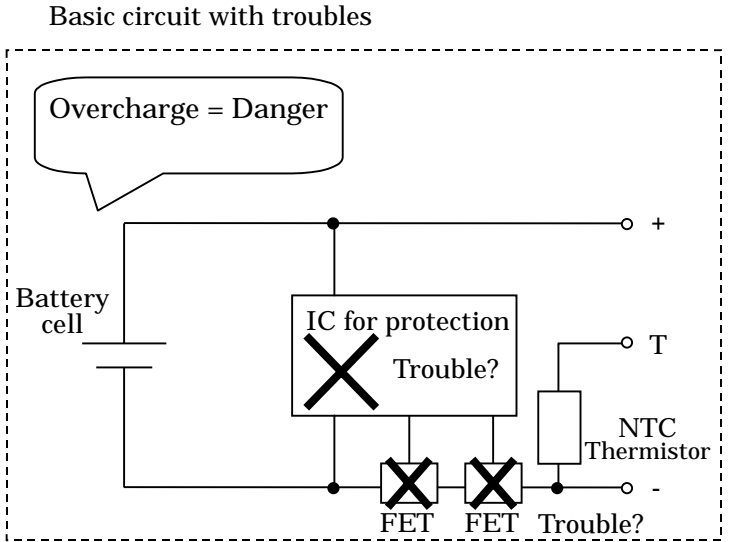

#### 2.1.2. The weak points of conventional double protection elements.

Protection devices such as temperature fuses and bimetals work by conducting the temperature rise in the battery to the inside of it via package or lead wire. Hence, they have a disadvantage that the response speed is slow, and the response speed fluctuates depending on the installation location of the device.

These elements obstruct a cost reduction since it is incompatible with the reflow soldering due to their structures, and must depend on manual soldering.

By using SC Protector, the battery cells won't become dangerous condition even if IC or FET breaks.

### 2.2. Characteristics

1) One device can protect against both overcharging and overcurrent.

2) Protection against overcharging is directly performed by the battery cell voltage, ensuring high accuracy and quick response, and the response speed does not fluctuate depending on the location and condition of installation.

3) At the same time of protection against overcharging, since it is constructed to send current to the heater via the fuse element, the fuse element forcibly fused by the heating of the heater and, upon the cutoff of charging circuit, the current to the heater automatically stops, and hence, SC Protector itself never overheated.

4) Abundant product lineup allows the selection of protector with optimal operating voltage and operating current depending on the cell structure of battery pack, ensuring high degree of freedom in the design of protection circuit.

5) It is compatible with automatic mounting using general-purpose chip mounter, and at the same time, compatible with the reflow soldering, contributing to the reduction of parts mounting cost.

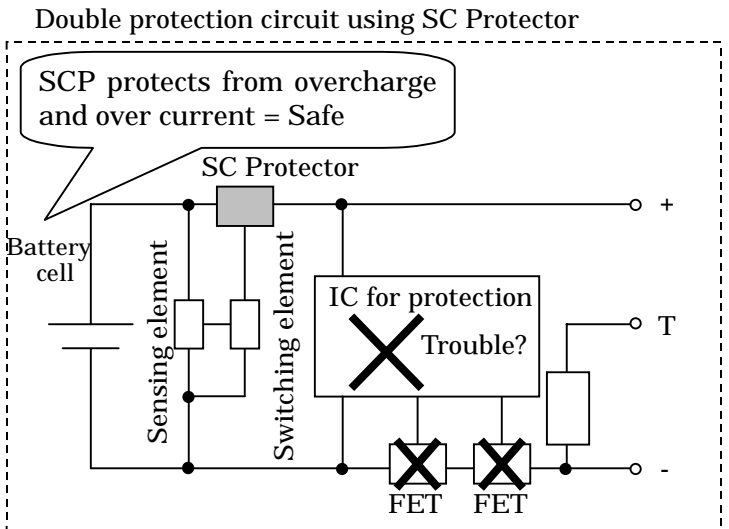

SC Protector has the strong points as shown above and it meets the safety requirement without spoiling the strong point of miniature of the Li-ion battery.

### 3. Relations between the fusion state and the operation mode

“The operation mode” can be estimated by the fusion state of the fuse element.

#### 3.1. Heater operation

In the case of overvoltage, “Both two sides of the middle electrode” are fused by the heater operation. Because the fuses are heated until the charge to the heater is stopped.

Only one side may be cut when the protection circuit is designed so that charging to the heater stops by cutting of one side of the middle electrode.

For the heater operation, it is characterized as “Fuses like flow into the middle electrode.”

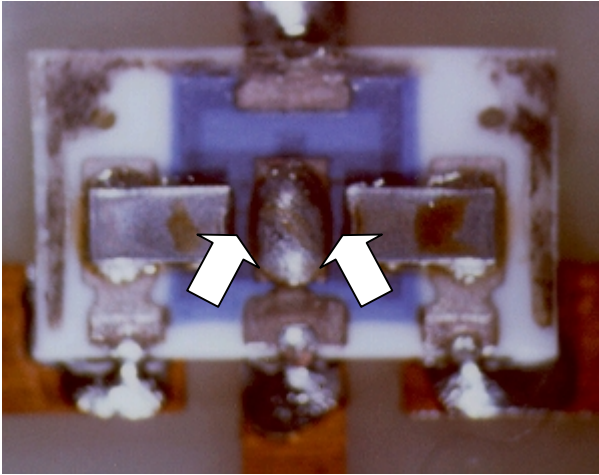

<Features of the heater operation>

- ◆ Fuses like flow into the middle electrode
- ◆ Both two side (or one side) is fused

#### 3.2. Current operation

In the case of overcurrent operation, basically, “only one position of the fuse is cut” because it is the same operation mode as the conventional electric current fuse. When the current exceeds 50A, two positions are cut occasionally.

For the current operation, it is characterized as “The cutting position isn’t fixed”, “It cuts like bursting”.

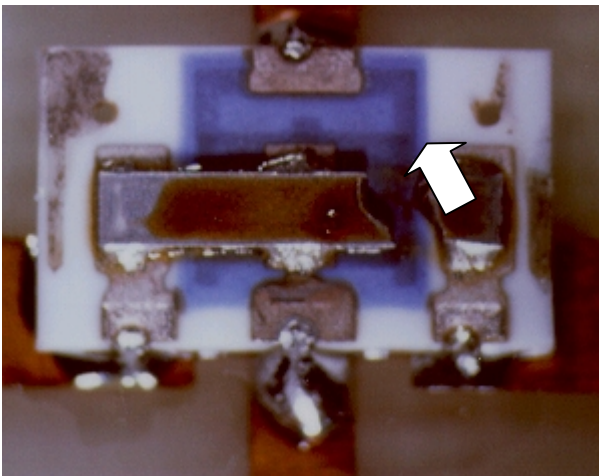

<Features of the current operation>

- ◆ Cutting position isn’t fixed
- ◆ It cuts like bursting
- ◆ One position is cut basically (Over 50A, two positions are cut occasionally)

#### 4. Basis of selection

Price <sup>(*1)</sup>	Soldering	Nominal Rated current	Current-carrying capacity <sup>(*2)</sup>			Current-rush withstand <sup>(*3)</sup>	Number of cells in series				Special edition <sup>(*6)</sup> 20V or more
			25°C	40°C	60°C		1 cell	2 cells	3 cells	4 cells	
Standard  (Exclude SFD-16x)	Reflow	5A	7.0A	6.0A	5.0A	30A-5ms	SFD-045A		SFD-125A	SFD-145B	SFD-165A
		7A	8.0A	7.0A	6.5A	80A-5ms	SFD-047A		SFD-127A	SFD-147B	SFD-167A
	Max 260°C	8A	9.0A	8.5A	7.0A	80A-5ms	SFD-048A		SFD-128B	SFD-148B	-
		12A	13.5A	12.0A	10.0A	100A-10ms <sup>(*4)</sup>	-		SFG-1212A	SFG-1412A	-
Low	Reflow	6A	7.0A	6.5A	5.5A	36A-5ms	SFE-046A	SFE-086A	SFE-126A	SFE-146A	SFE-246A
	Max 245°C	8A	9.0A	8.5A	7.0A	50A-5ms 100A-0.5ms <sup>(*5)</sup>	SFE-048A	SFE-088A	SFE-128A	SFE-148A	-

Common model of thermal fuse with heater

Soldering iron Spot reflow	10A	7A at 40°C (Fusing-off by 9A at 40°C)	-
-------------------------------	-----	--	---

(\*1) It is a relative expression between SFD/SFG and SFE.

(\*2) It is the typical value that is calculated from 100 , the temperature that we confirmed the reliability with our company's standard PCB (0.6t Glass Epoxy single-sided copper-clad laminates). It is influenced by thermal capacity of PCB and so we recommend checking it with your PCB.

- 25 , 40 and 60 are ambient temperature.
- The temperature that we confirmed the reliability is not a critical condition. SCP fusing-off temperature is 200 or more.
- Current-carrying capacity is measured in thermal equilibrium condition. Therefore, if Current-carrying time is short, Current-carrying capacity will increase.

(\*3) It is the test condition (5ms-On, 995ms-Off, 5000cycle) that we confirmed the reliability. But it is not necessarily a critical condition for SCP.

(\*4) It is the test condition (10ms-On, 9990ms-Off, 1000cycle) that we confirmed the reliability. But it is not necessarily a critical condition for SCP.

(\*5) We recommend using IC that can interrupt current by 0.5ms or less when SFE-xx8A is adopted in the module that has 80A or more rush current.

(\*6) SFD-16xA is special edition that has high operating voltage. Therefore, we recommend using SFx-14xx for 4cells in series.

5. External view & Equivalent circuit

5.1. SFC series (Rated current 5A)

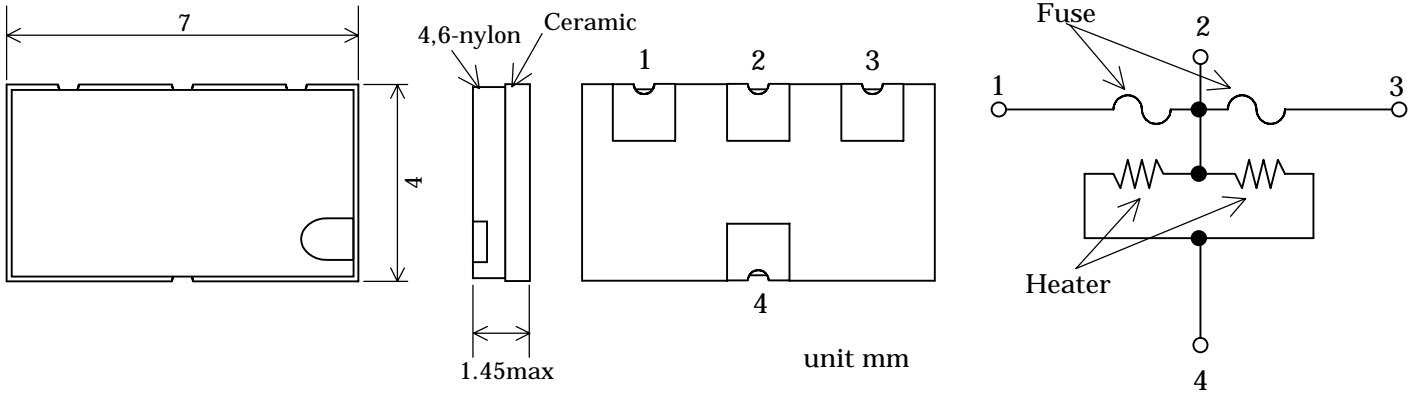

5.2. SFD/SFE series (Rated current 5-8A)

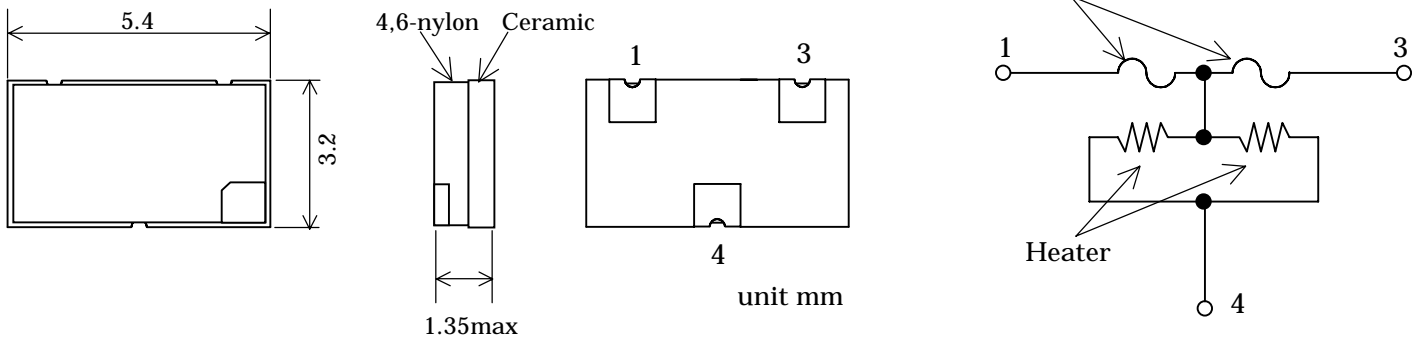

5.3. SFG series (Rated current 12A)

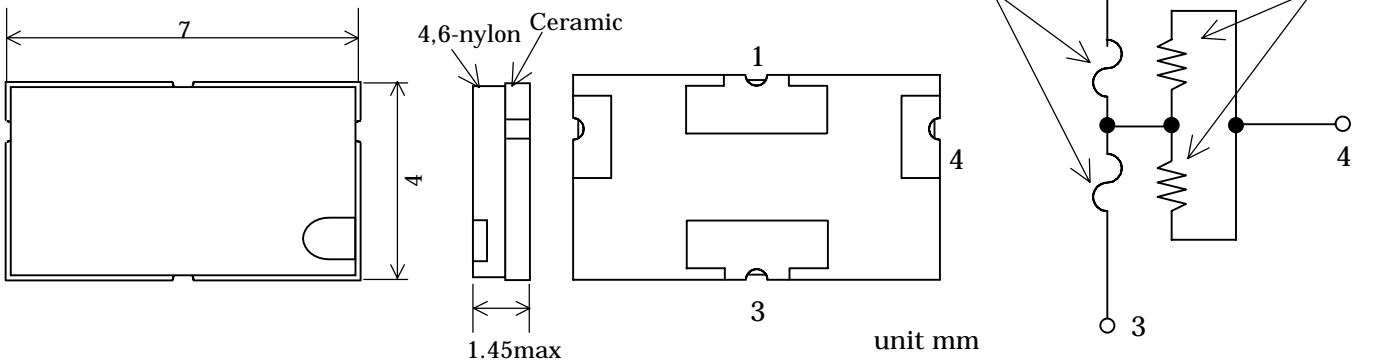

5.4. SFH series (Rated current 12A)

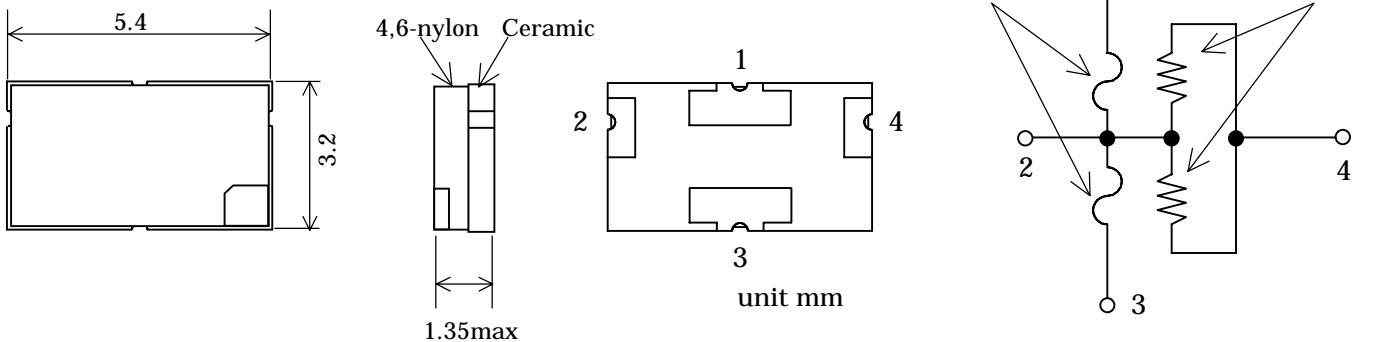

6. Terminal Size (Unit: mm. Not in scale.)

6.1. SFC series (Rated current 5A)

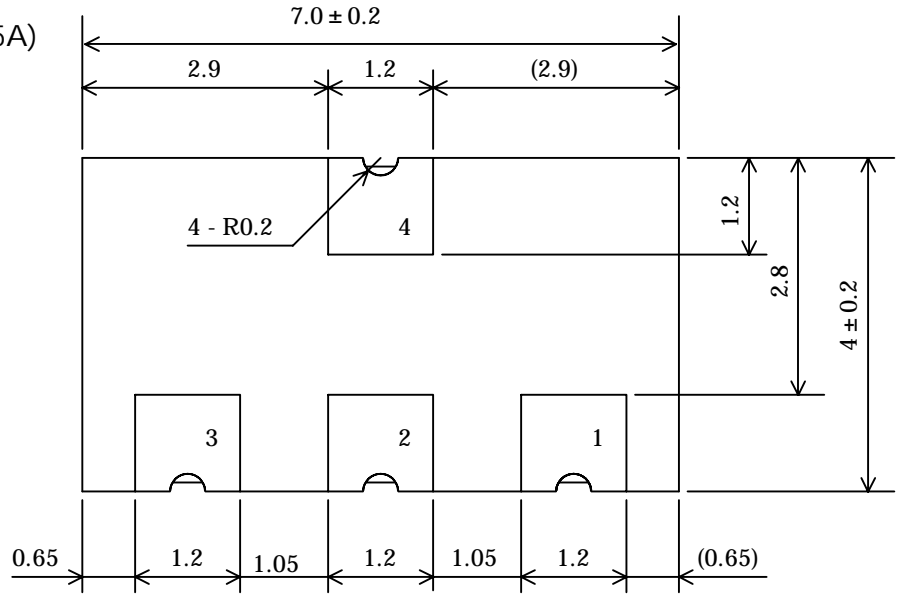

6.2. SFD/SFE series (Rated current 5-6A)

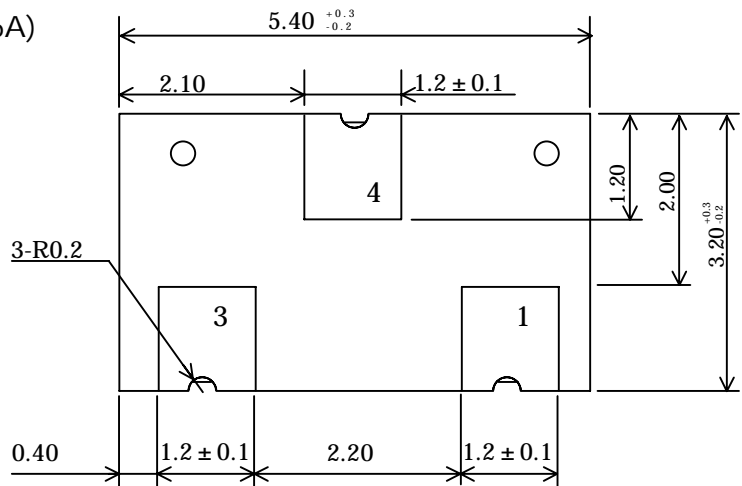

6.3. SFD series (Rated current 7A)

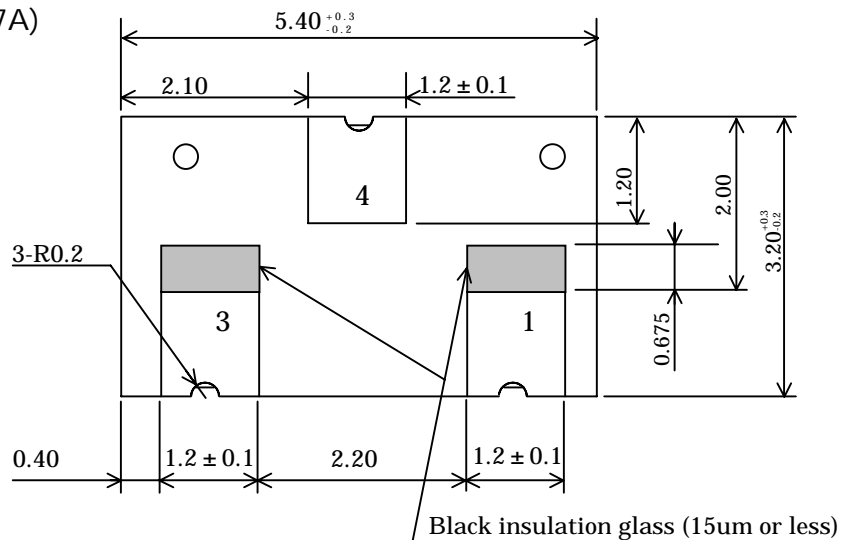

6.4. SFD/SFE series (Rated current 8A)

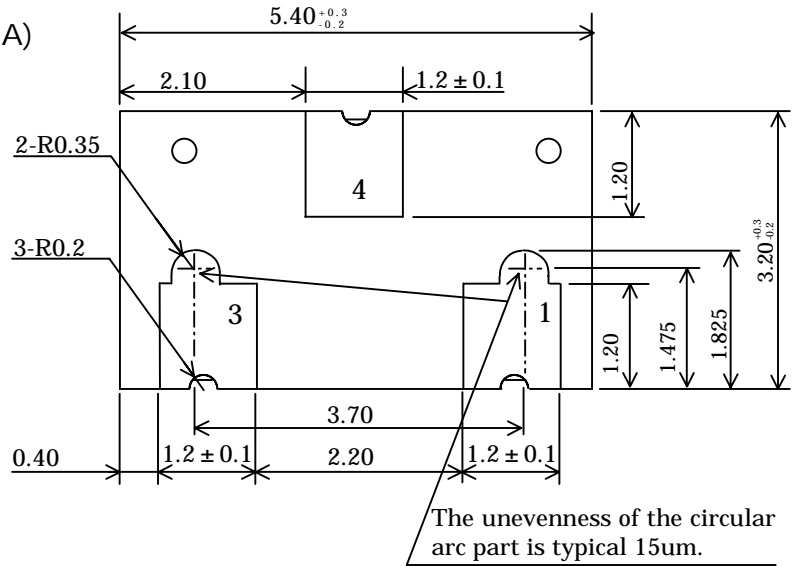

6.5. SFG series (Rated current 12A)

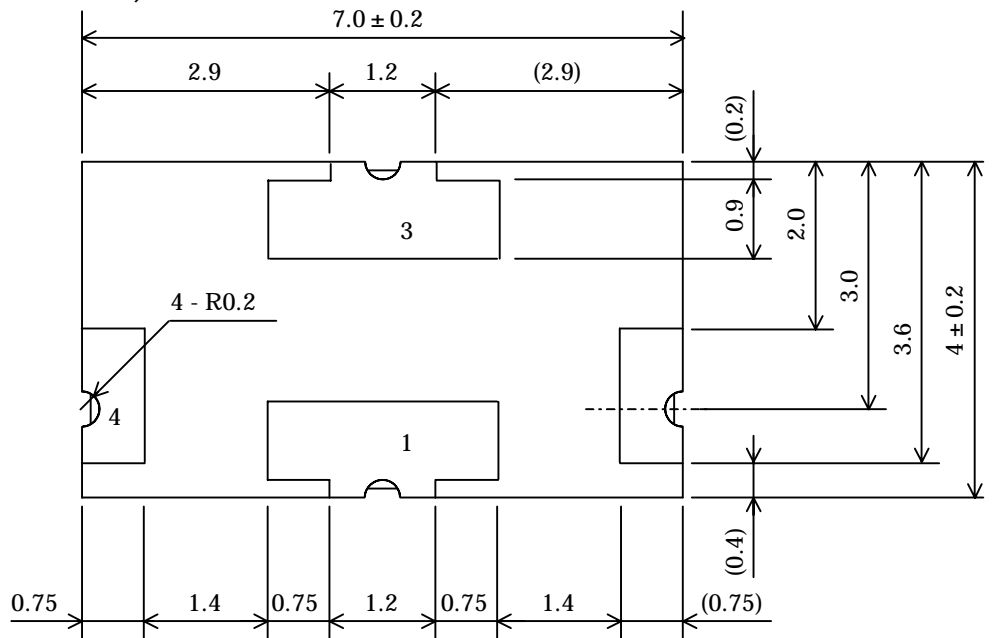

## 7. Specification

### 7.1. General

	SC Protector
Qualification	UL248-14 (File No. E167588) , TUV (Certificate No. J9650637)
Rated voltage(*)	36VDC
Rated breaking capacity	50A

(\*) is the maximum voltage can be cut off by fuse. It is not the operational voltage of the heater.

### 7.2. SFC series

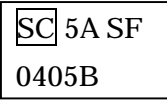
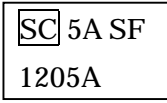
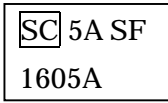
	for 1-2 cells in series	for 3 cells in series	for 4 cells in series
	SFC-0405B	SFC-1205A	SFC-1605A
Rated current	5A		
Size	7.0 × 4.0 × 1.45		
Electrode	Ag-Pd		
Fuse resistance 1-3 (Typical)	15 ± 3m		
Operating electric power	3.5 ~ 22W		
Operating voltage	4.0 ~ 9.0V	7.8 ~ 17.9V	8.5 ~ 19.3V
Heater resistance	4.1 ± 0.4	16.0 ± 1.5	18.9 ± 1.9
Marking			
Reflowing temperature (MAX)	260		

### 7.3. SFD series

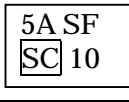
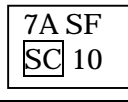
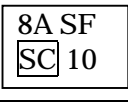
SFD-04X for 1-2 cells in series	SFD-045A	SFD-047A	SFD-048A
Rated current	5A	7 A	8A
Size	5.4 × 3.2 × 1.35		
Electrode	Au plated Ag-Pt		
Fuse resistance (Typical)	12 ± 2m	6.5 ± 1.5m	5.5 ± 1.0m
Operating electric power	3.5 ~ 22W		4.0 ~ 22W
Operating voltage	4.0 ~ 9.0V		4.3 ~ 9.0V
Heater resistance	4.1 ± 0.4		
Marking			
Reflowing temperature (MAX)	260		

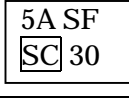
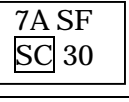
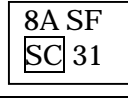

SFD-12X for 3 cells in series	SFD-125A	SFD-127A	SFD-128B
Rated current	5A	7 A	8A
Size	5.4 × 3.2 × 1.35		
Electrode	Au plated Ag-Pt		
Fuse resistance (Typical)	12 ± 2m	6.5 ± 1.5m	5.5 ± 1.0m
Operating electric power	3.5 ~ 22W		4.0 ~ 22W
Operating voltage	7.5 ~ 17.0V		6.5 ~ 13.6V
Heater resistance	14.6 ± 1.5		9.4 ± 0.9
Marking			
Reflowing temperature (MAX)	260		

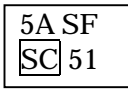
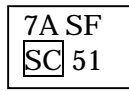
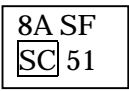

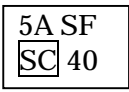
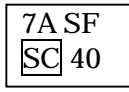
SFD-14X for 4 cells in series	SFD-145B	SFD-147B	SFD-148B
Rated current	5A	7 A	8A
Size	5.4 × 3.2 × 1.35		
Electrode	Au plated Ag-Pt		
Fuse resistance (Typical)	12 ± 2m	6.5 ± 1.5m	5.5 ± 1.0m
Operating electric power	3.5 ~ 22W		4.0 ~ 22W
Operating voltage	9.7 ~ 19.6V		10.3 ~ 19.6V
Heater resistance	22.0 ± 4.4		
Marking			
Reflowing temperature (MAX)	260		

SFD-16X for High Voltage	SFD-165A	SFD-167A
Rated current	5A	7 A
Size	5.4 × 3.2 × 1.35	
Electrode	Au plated Ag-Pt	
Fuse resistance (Typical)	12 ± 2m	6.5 ± 1.5m
Operating electric power	3.5 ~ 22W	
Operating voltage	11.1 ~ 25.0V	
Heater resistance	31.6 ± 3.2	
Marking		
Reflowing temperature (MAX)	260	

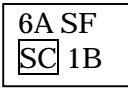
#### 7.4. SFE series

SFE-04X for 1 cell in series	SFE-046A	SFE-048A
Rated current	6A	8A
Size	5.4 × 3.2 × 1.35	
Electrode	Ag-Pt	
Fuse resistance (Typical)	9 ± 2m	5 ± 1.5m
Operating electric power	3.5 ~ 22W	3.5 ~ 20W
Operating voltage	4.0 ~ 8.2V	4.0 ~ 7.0V
Heater resistance	3.8 ± 0.7	3.5 ± 1.0
Marking		
Reflowing temperature (MAX)	245	

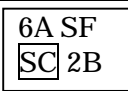
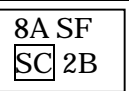
SFE-08X for 2 cells in series	SFE-086A	SFE-088A
Rated current	6A	8A
Size	5.4 × 3.2 × 1.35	
Electrode	Ag-Pt	
Fuse resistance (Typical)	9 ± 2m	5 ± 1.5m
Operating electric power	3.5 ~ 22W	3.5 ~ 20W
Operating voltage	5.6 ~ 10.2V	5.6 ~ 9.8V
Heater resistance	6.9 ± 2.1	
Marking		
Reflowing temperature (MAX)	245	

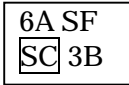
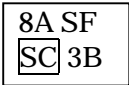
SFE-12X for 3 cells in series	SFE-126A	SFE-128A
Rated current	6A	8A
Size	5.4 × 3.2 × 1.35	
Electrode	Ag-Pt	
Fuse resistance (Typical)	9 ± 2m	5 ± 1.5m
Operating electric power	3.5 ~ 22W	3.5 ~ 20W
Operating voltage	7.8 ~ 16.0V	8.0 ~ 14.1V
Heater resistance	14.6 ± 2.9	14.2 ± 4.2
Marking		
Reflowing temperature (MAX)	245	

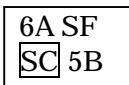
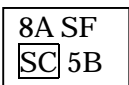
SFE-14X for 4 cells in series	SFE-146A	SFE-148A
Rated current	6A	8A
Size	5.4 × 3.2 × 1.35	
Electrode	Ag-Pt	
Fuse resistance (Typical)	9 ± 2m	5 ± 1.5m
Operating electric power	3.5 ~ 22W	3.5 ~ 20W
Operating voltage	9.7 ~ 19.6V	11.2 ~ 19.6V
Heater resistance	22.0 ± 4.4	27.6 ± 8.3
Marking		
Reflowing temperature (MAX)	245	

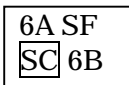
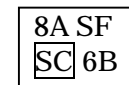
SFE-24X for 5-6 cells in series	SFE-246A	SFE-248A(*)
Rated current	6A	8A
Size	5.4 × 3.2 × 1.35	
Electrode	Ag-Pt	
Fuse resistance (Typical)	9 ± 2m	5 ± 1.5m
Operating electric power	3.5 ~ 22W	3.5 ~ 18W
Operating voltage	14.1 ~ 26.1V	15.8 ~ 26.3V
Heater resistance	44.0 ± 13.0	55.0 ± 16.5
Marking		
Reflowing temperature (MAX)	245	

(\*) under development

### 7.5. SFG series

	for 1 cell in series	for 3 cells in series	for 4 cells in series
	SFG-0412A(*)	SFG-1212A	SFG-1412A
Rated current	12A		
Size	7.0 × 4.0 × 1.45		
Electrode	Ag-Pt		
Fuse resistance (Typical)	3 ± 1m		
Operating electric power	6 ~ 35W		
Operating voltage	4.0 ~ 7.0V	7.8 ~ 13.8V	10.5 ~ 18.5V
Heater resistance	2.0 ± 0.6	7.8 ± 2.3	14.0 ± 4.2
Marking	12A G1 SC SF	12A G3 SC SF	12A G4 SC SF
Reflowing temperature (MAX)	260		

(\*) under development

### 7.6. SFH series

	for 1 cell in series	for 3 cells in series	for 4 cells in series
	SFH-0412A(*)	SFH-1212A(*)	SFH-1412A(*)
Rated current	12A		
Size	5.4 × 3.2 × 1.35		
Electrode	Ag-Pt		
Fuse resistance (Typical)	3 ± 1m		
Operating electric power	5 ~ 30W		
Operating voltage	4.0 ~ 7.1V	7.7 ~ 13.8V	10.4 ~ 18.5V
Heater resistance	2.4 ± 0.7	9.1 ± 2.7	16.4 ± 4.9
Marking	12A H1 SC SF	12A H3 SC SF	12A H4 SC SF
Reflowing temperature (MAX)	260		

(\*) under development

## 8. Temperature profile of reflow soldering

The temperature shown below is the temperature of the electrode portion of SC Protector.

### 8.1. Temperature profile of 245 peak

Applicable to: SFC, SFD, SFE, SFG, SFH Type

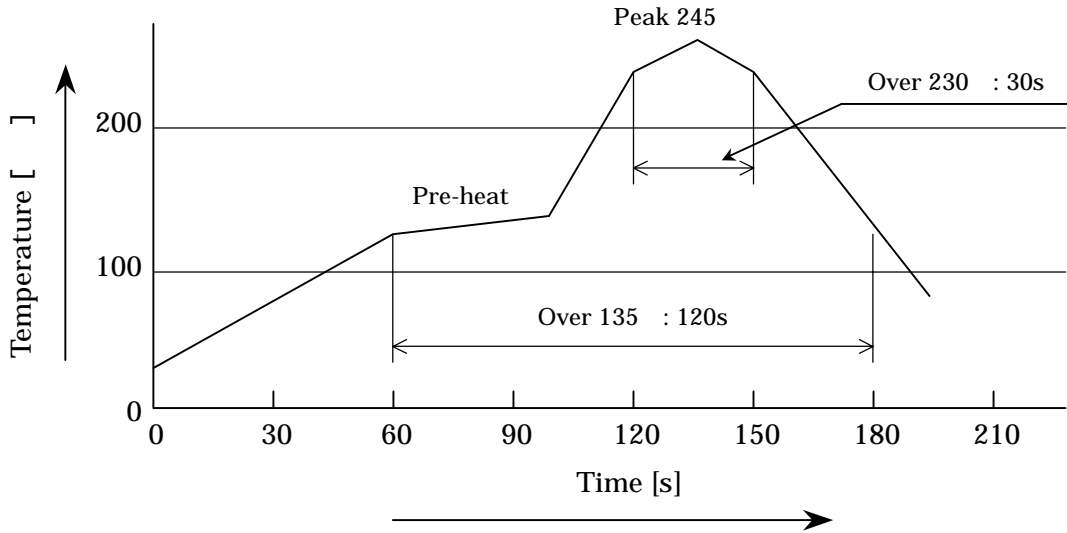

### 8.2. Temperature profile of 260 peak

Applicable to: SFC, SFD, SFE, SFG, SFH Type (Not applicable to SFE Type)

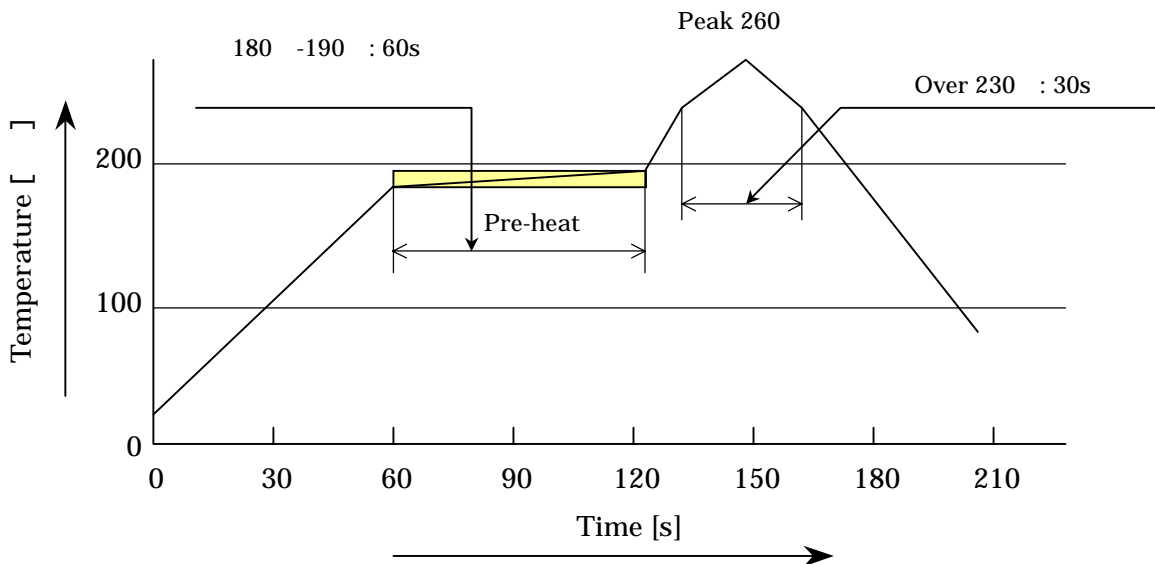

## 9. Voltage operation

### 9.1. Operating electric power and Operating voltage

1) Operating electric power range: Electricity Power applied to heater

2) Operating voltage range: Values are calculated from operating electric power range and heater resistance. Protector operation is normal under voltage applied to heaters in these ranges. Operating voltage range is adjustable by regulating heater resistance.

$$(\text{Operating voltage[V]} = \frac{\text{Operating electric power [W]} \times \text{Heater resistance[ } \Omega \text{]})$$

### 9.2. Voltage operation test method

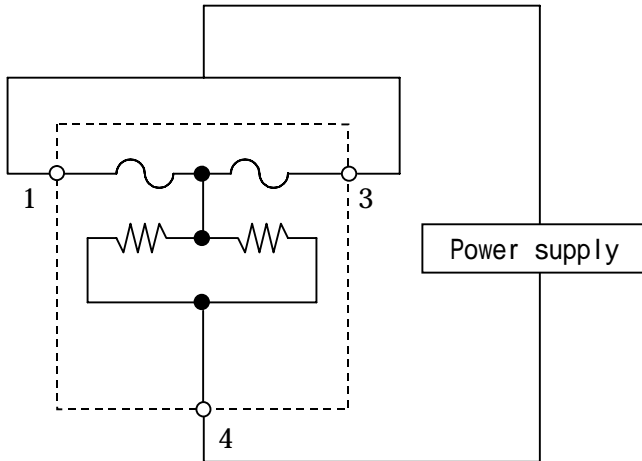

- 1) Connect SC Protector with a constant power supply.
- 2) Apply a current to the heater.
- 3) Measure the time the fuses take to melt.

### 9.3. Operation time by the heater (Electricity vs. clearing time at 25°C)

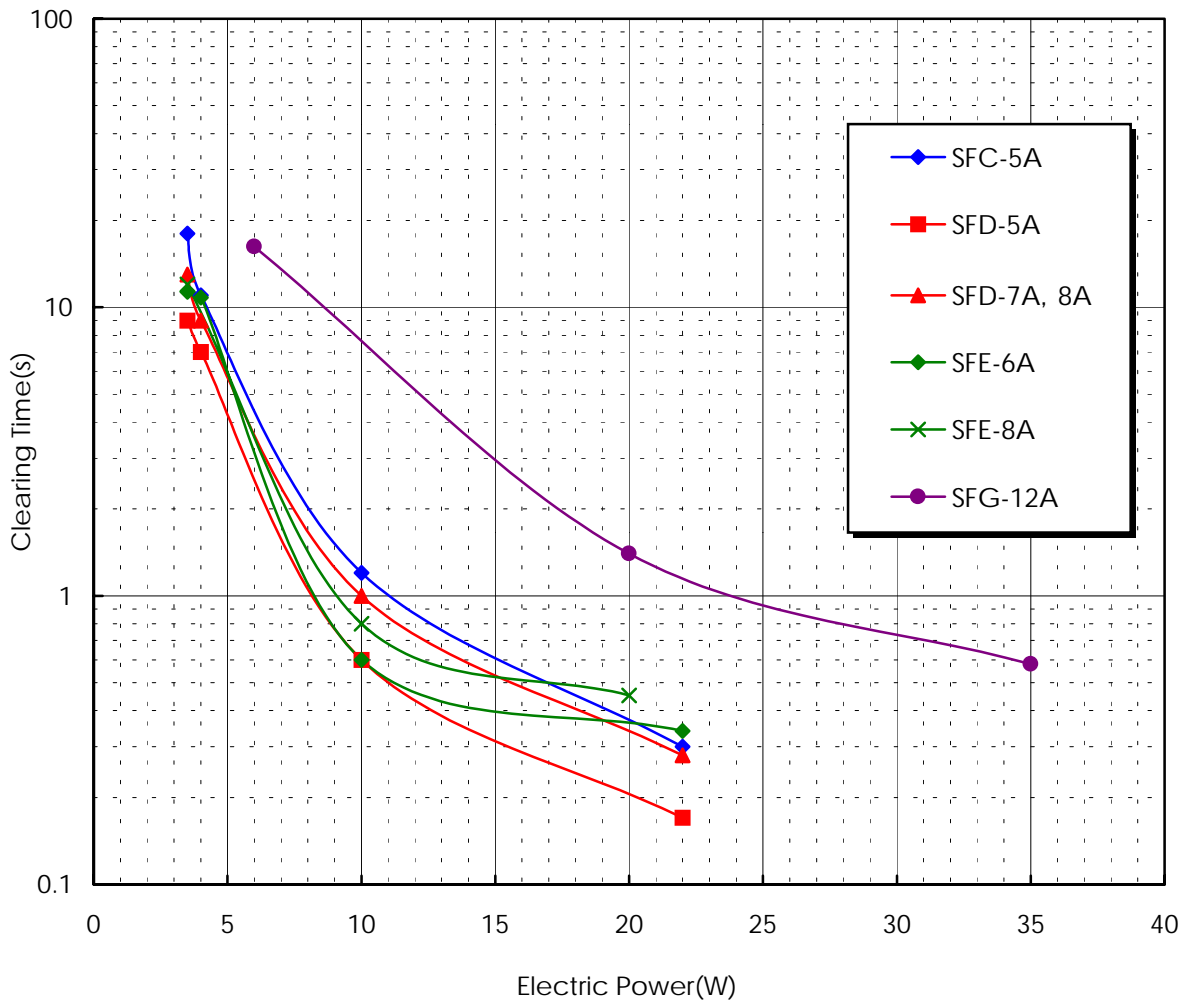

9.4. Operation time by the heater (Voltage vs. clearing time at 25°C)

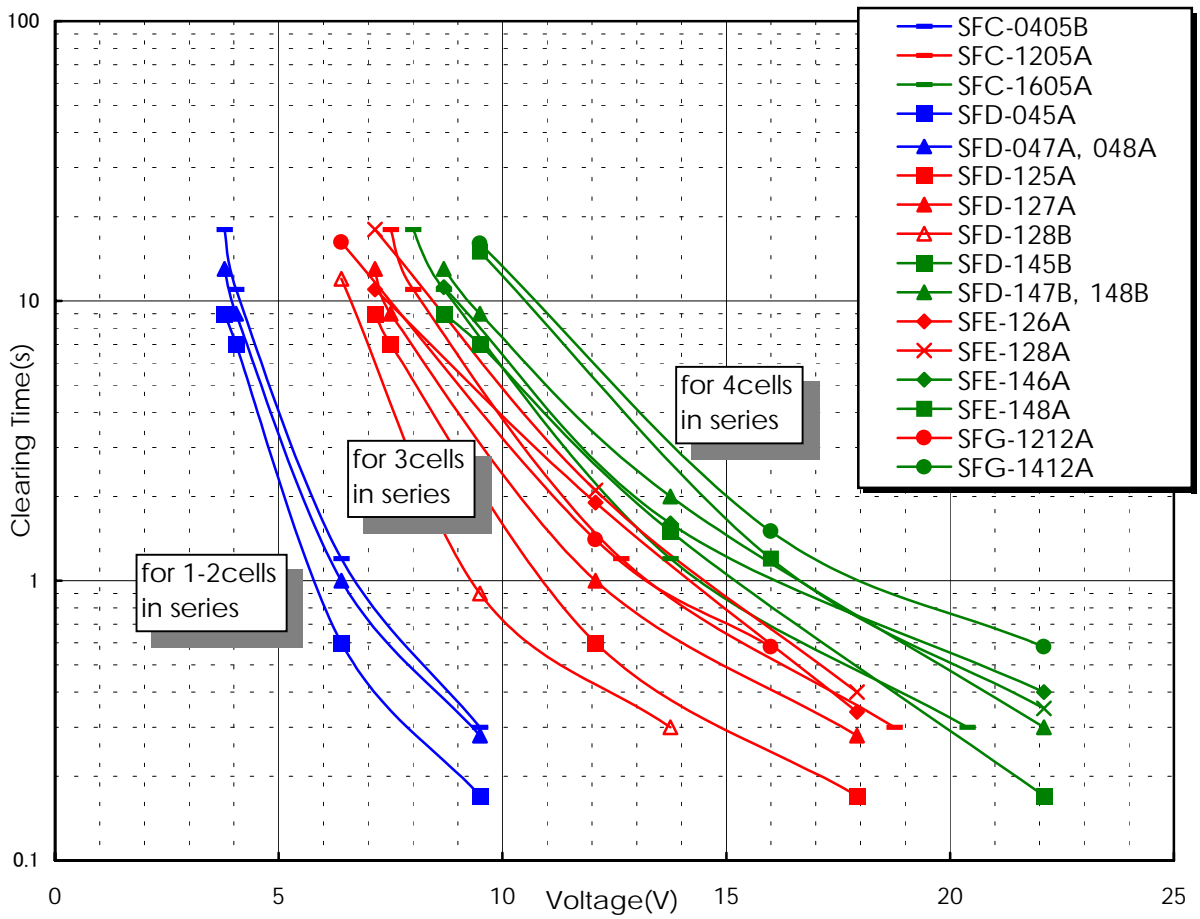

9.5. Operation time by the heater (Ambient temperature vs. clearing time)

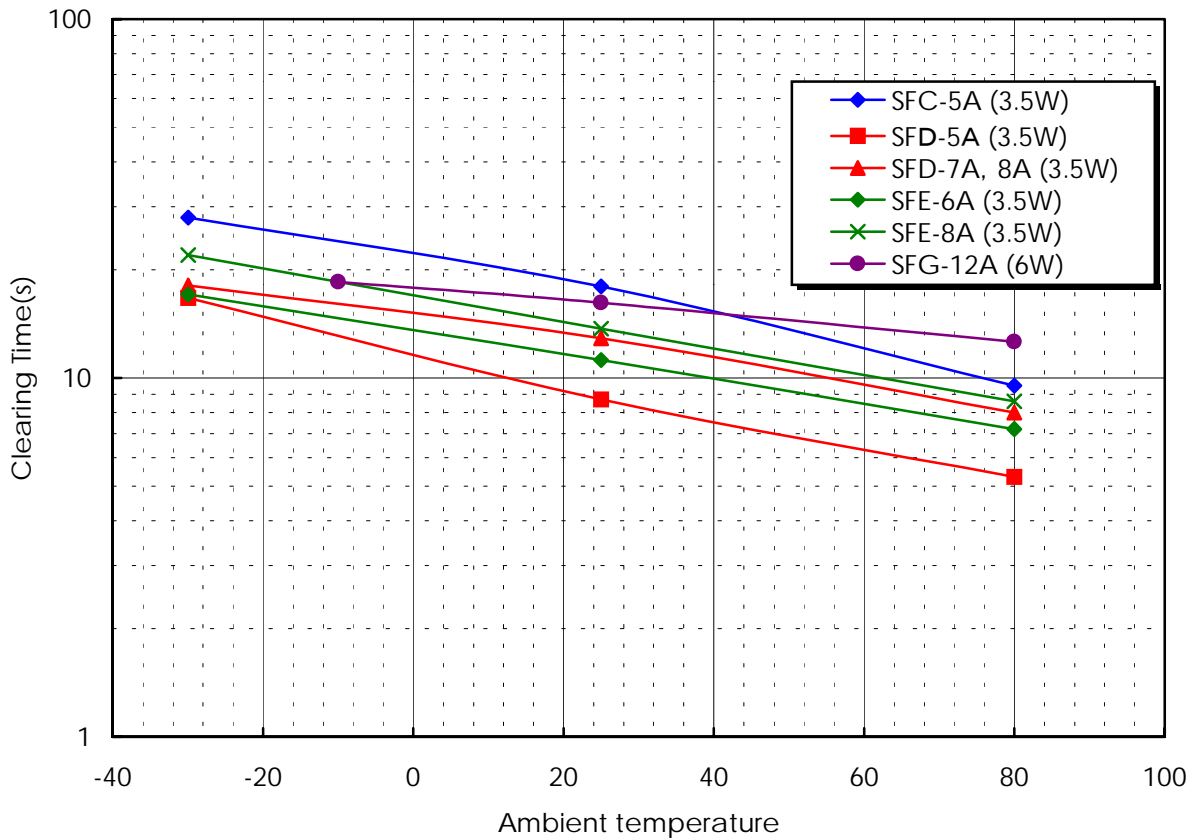

10. Current interrupting time (at 25°C)

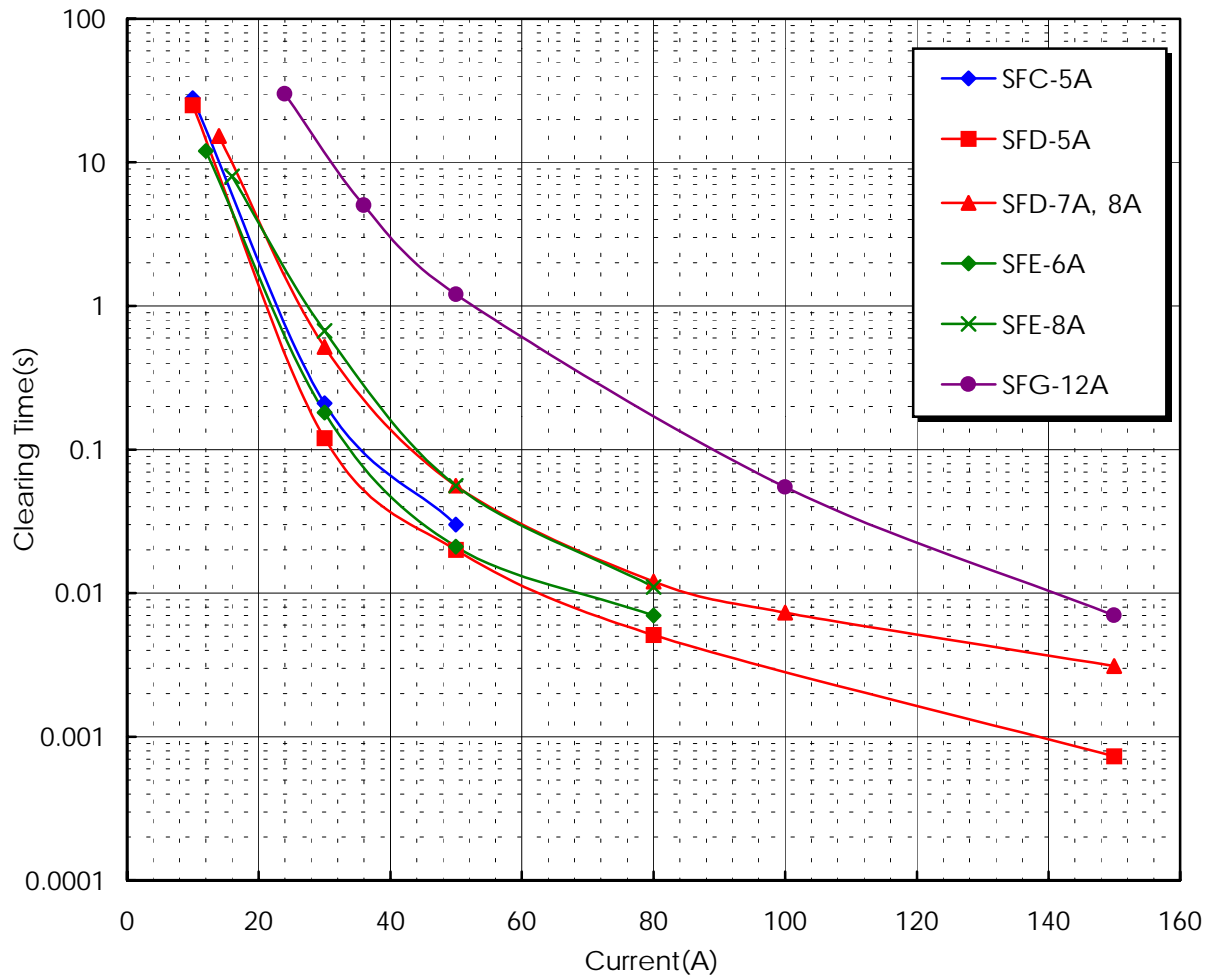

10.1. Current interrupting time (Ambient temperature vs. Clearing time by Rated Current \* 2)

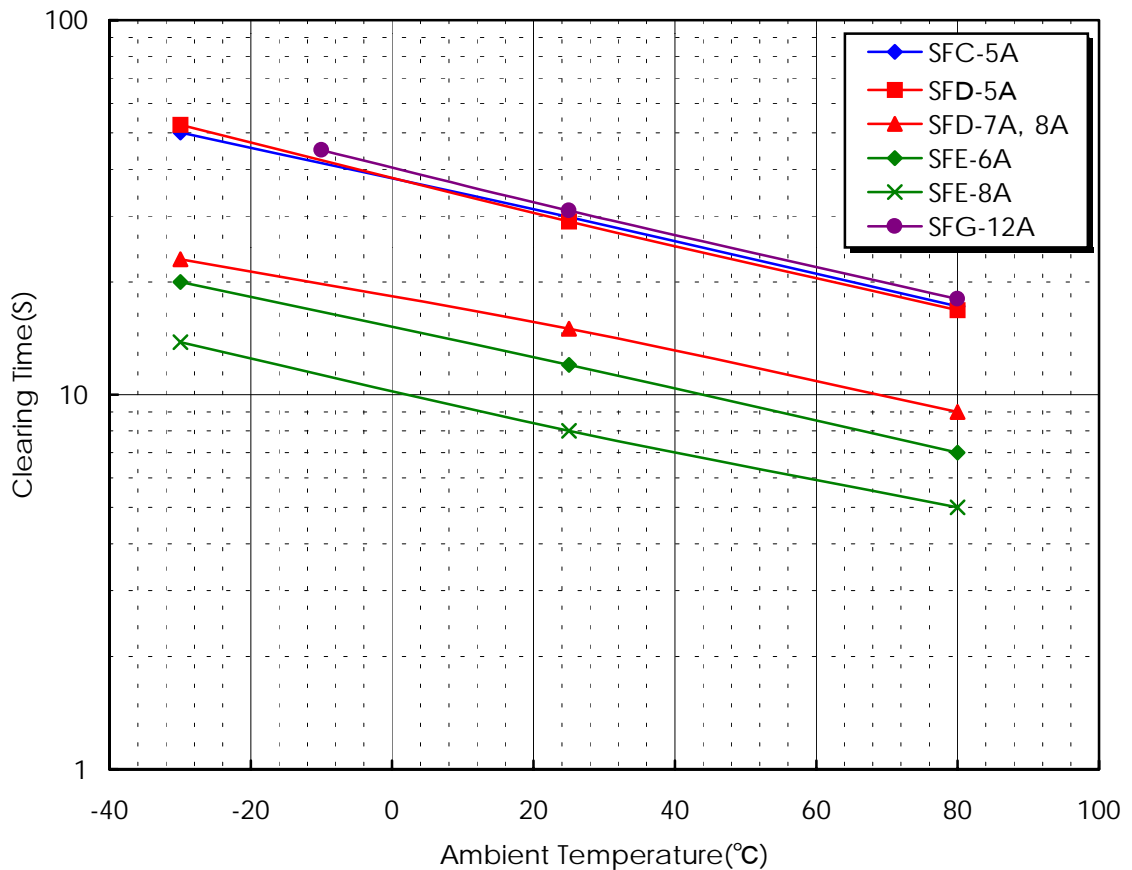

## 11. Others

### 11.1. Catalog data is the typical value.

- 1) Catalog data is not a guaranteed value.
- 2) Catalog data is measured with our company's standard PCB (0.6t Glass Epoxy single-sided copper-clad laminates). The characteristics are influenced by thermal capacity of PCB. Generally, when thermal capacity of PCB increases, Current-carrying capacity will increase and Clearing-time will be long.

### 11.2. Please select the product on the basis of [Current-carrying capacity].

- 1) Nominal rated current is provided on the basis of UL standard (The maximum temperature rise on body or contact that is passed the current shall not exceed 70°C) and so it is not Current-carrying capacity. Therefore, please select a product on the basis of Current-carrying capacity instead of Nominal rated current.
- 2) Current-carrying capacity is influenced by thermal capacity of PCB. Therefore we recommend checking it on your PCB.
- 3) We accept the test (Current-carrying capacity and Clearing-characteristics and so on) with your PCB. Please request to us unreservedly.

### 11.3. Current-carrying capacity

- 1) Current-carrying capacity is the current-carrying value that SCP reaches temperature that we confirmed the reliability in our company.
- 2) The temperature that we confirmed the reliability is 100 . But it is not a critical condition for SCP. For example, if SCP temperature exceeds it, SCP is not immediately fusing-off like a common thermal fuse. SCP fusing-off temperature is 200 or more and so it has much more capability for the temperature rise.
- 3) Current-carrying capacity is measured in thermal equilibrium condition so that if Current-carrying time is short, Current-carrying capacity will increase.

### 11.4. Precautions regarding handling

- 1) Make sure that the terminals of this product are connected on the lands of the circuit board, and that the resistance between terminal1-4 and 3-4 are rated heater resistance.
- 2) Ultrasonic cleansing or immersion cleansing must not be done for SCP. When cleansing is done, flux in element flows, and the specification will not be satisfied. These products after cleansing will be not guaranteed.

---

---

## Sony Chemicals Corporation

### SIP Division

1-11-2, Osaki, Shinagawa-ku, Tokyo, 141-0032 Japan  
TEL+81-3-5435-3943 FAX+81-3-5435-3072